

LifeFitness

ARCTIC SILVER 95Se Stairclimber

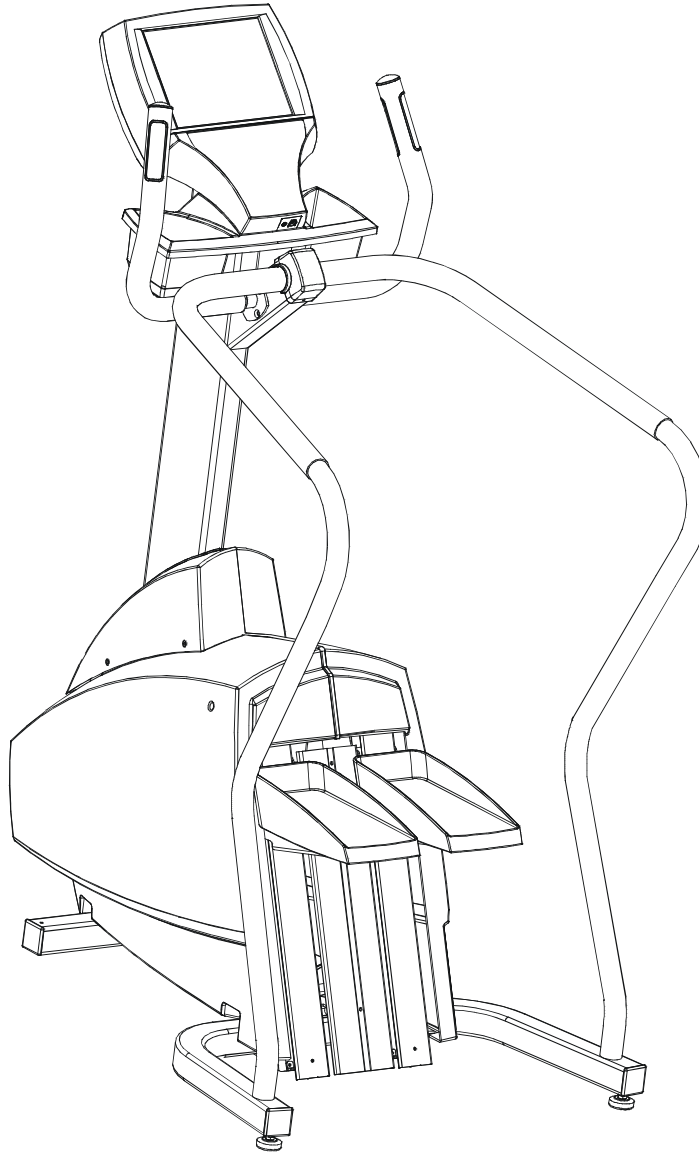

Customer Support Services
PARTS MANUAL rev 14 Jul 2008

ARCTIC SILVER 95SE
REFERENCES

95SE-0XXX-04
S/N MSU100000 and up

OPERATION MANUAL – (ENG)	M051-00K47-A136
OPERATION MANUAL – (F/S/P)	M051-00K47-A137
OPERATION MANUAL – (G/D/I)	M051-00K47-A138
OPERATION MANUAL – (JAP)	M051-00K47-A139
OPERATION MANUAL – (CHI)	M051-00K47-A140
PARTS BAG	AK47-00123-0001
HARDWARE BAG	AK47-00106-0000
POWER SUPPLY 12V, 4.5A Without Line Cord	118E-00001-0161
LINE CORD, DOM. 10A 125V	0017-00003-0704
LINE CORD, CON. 10A 250V	0017-00003-0691
LINE CORD, 10A U.K.	0017-00003-0889
LINE CORD, AUSTRALIA	0017-00003-0918
TOUCH-UP PAINT: SPRAY CAN	0017-00008-0204
.5 OZ. BOTTLE	0017-00008-0205
.33 OZ. PEN	0017-00008-0206
SERVICE MANUAL	M051-00K47-A013

	Page
CONSOLE ASSEMBLY	4
CONSOLE COMPONENTS.....	5
FRAME COMPONENTS.....	6
SHROUDS AND PEDAL TUBE	7
PEDAL ASSEMBLY.....	8
CLUTCH/SHAFT/PULLEY ASSEMBLY	9
LEFT CLUTCH ASSEMBLY	10
CROSSOVER PULLEY ASSEMBLY	11
ALTERNATOR ASSEMBLY.....	12
GUIDE ROLLERS	13
POWER CONTROL BOARD & RESISTORS	14
POLAR CAP & HR ELECTRODES	15
CABLES.....	16

The version –04, 95SE has both Life Pulse sensors and Telemetry for reading Heart rate.

ARCTIC SILVER 95SE
Console Assembly

95SE-0XXX-04
S/N MSU100000 and up

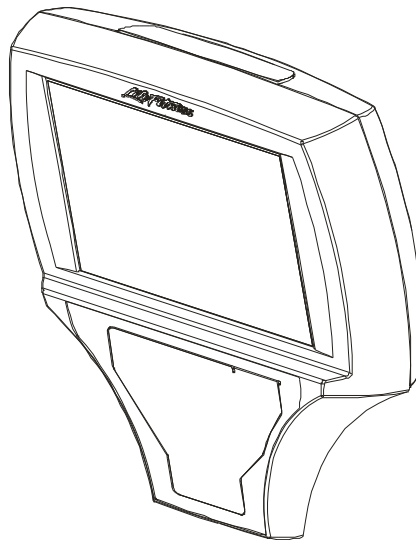

CONSOLE ASSEMBLY	
Part Number	Description
AK47-00174-0001	CONS-ASSY: MFG; 95SE-04; NTSC; ENG
AK47-00174-0004	CONS-ASSY: MFG; 95SE-04; NTSC; SPN
AK47-00174-0006	CONS-ASSY: MFG; 95SE-04; NTSC; JAP
AK47-00174-0007	CONS-ASSY: MFG; 95SE-04; NTSC; FRN
AK47-00174-0011	CONS-ASSY: MFG; 95SE-04; NTSC; CHI
AK47-00175-0002	CONS-ASSY: MFG; 95SE-04; PAL; ENG
AK47-00175-0003	CONS-ASSY: MFG; 95SE-04; PAL; GER
AK47-00175-0004	CONS-ASSY: MFG; 95SE-04; PAL; SPN
AK47-00175-0007	CONS-ASSY: MFG; 95SE-04; PAL; FRN
AK47-00175-0008	CONS-ASSY: MFG; 95SE-04; PAL; ITL
AK47-00175-0009	CONS-ASSY: MFG; 95SE-04; PAL; DUT
AK47-00175-0010	CONS-ASSY: MFG; 95SE-04; PAL; POR
AK47-00175-0011	CONS-ASSY: MFG; 95SE-04; PAL; CHI

ARCTIC SILVER 95SE

Console Components

95SE-0XXX-04

S/N MSU100000 and up

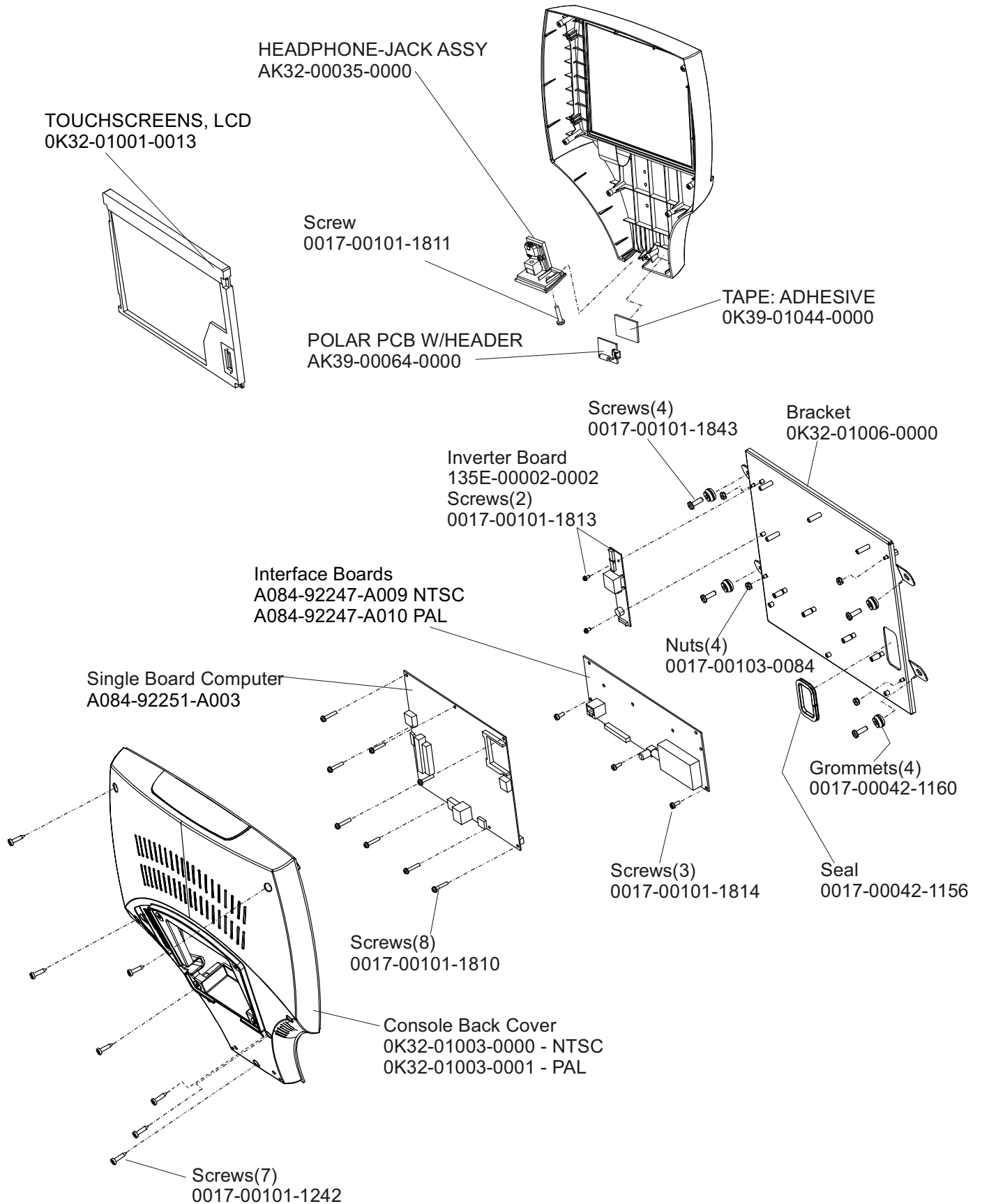

ARCTIC SILVER 95SE
Frame Components

95SE-0XXX-04
S/N MSU100000 and up

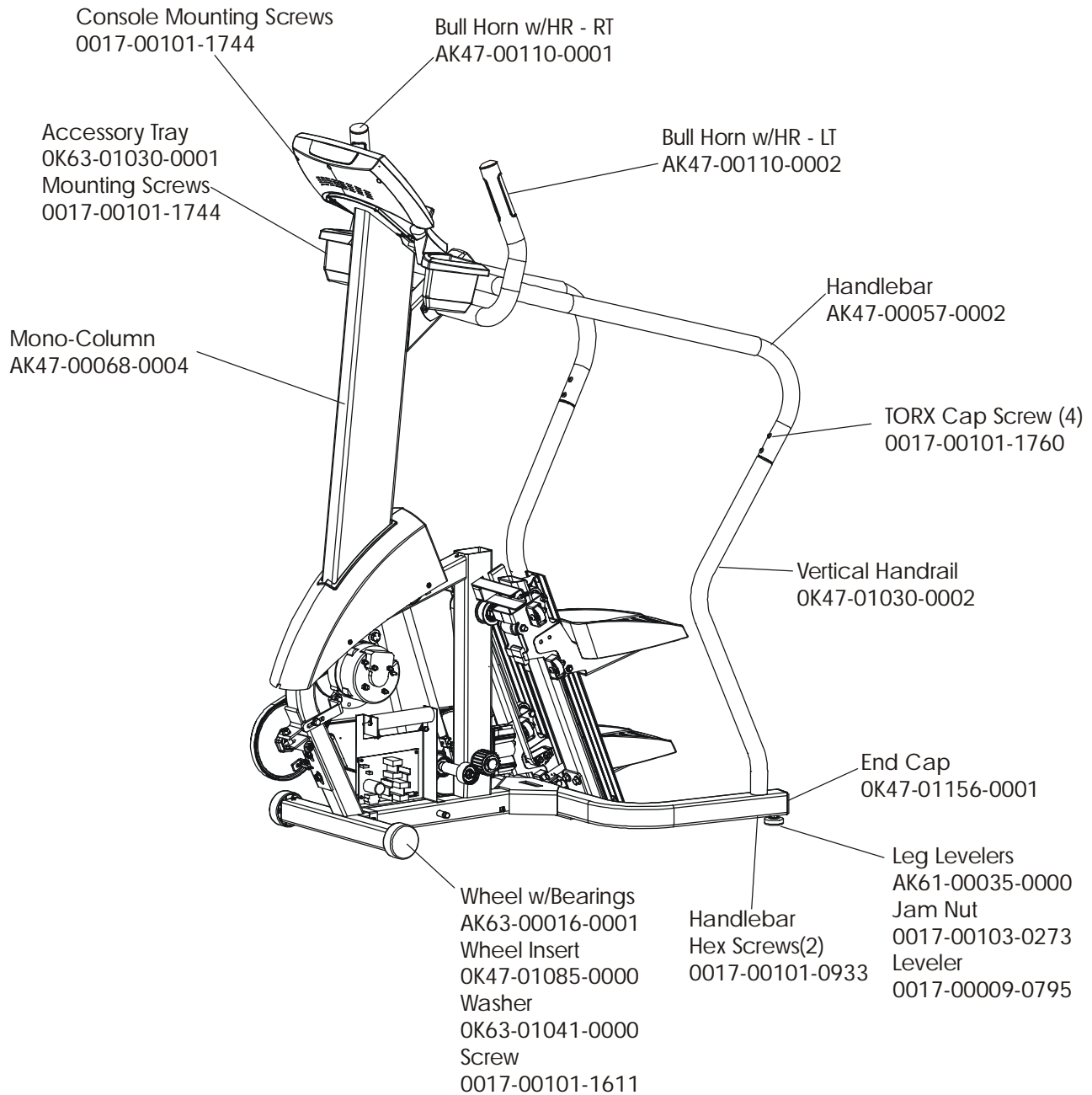

ARCTIC SILVER 95SE

Shrouds and Pedal Tube

95SE-0XXX-04
S/N MSU10000 and up

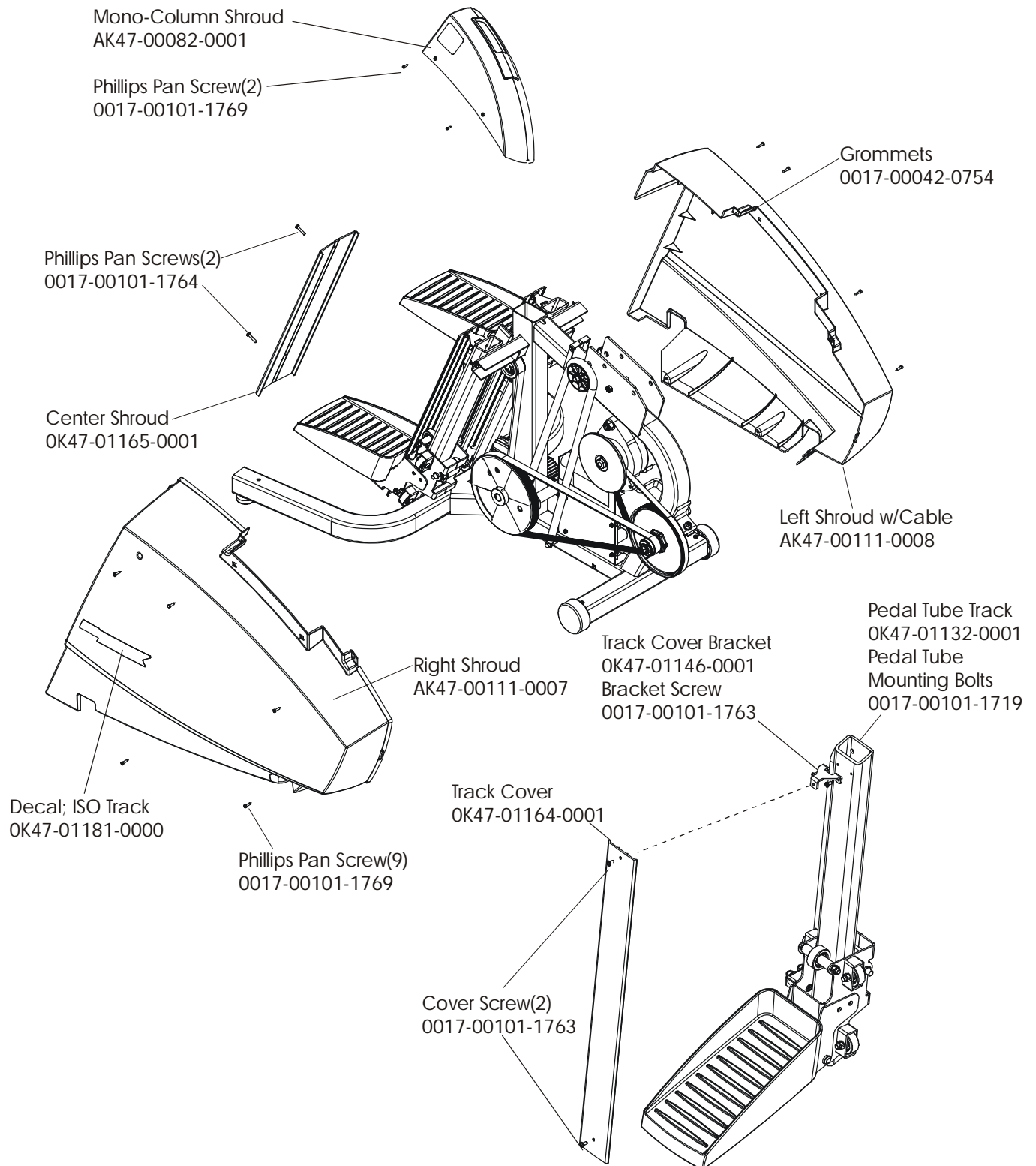

ARCTIC SILVER 95SE

Pedal Assembly

95SE-0XXX-04
S/N MSU10000 and up

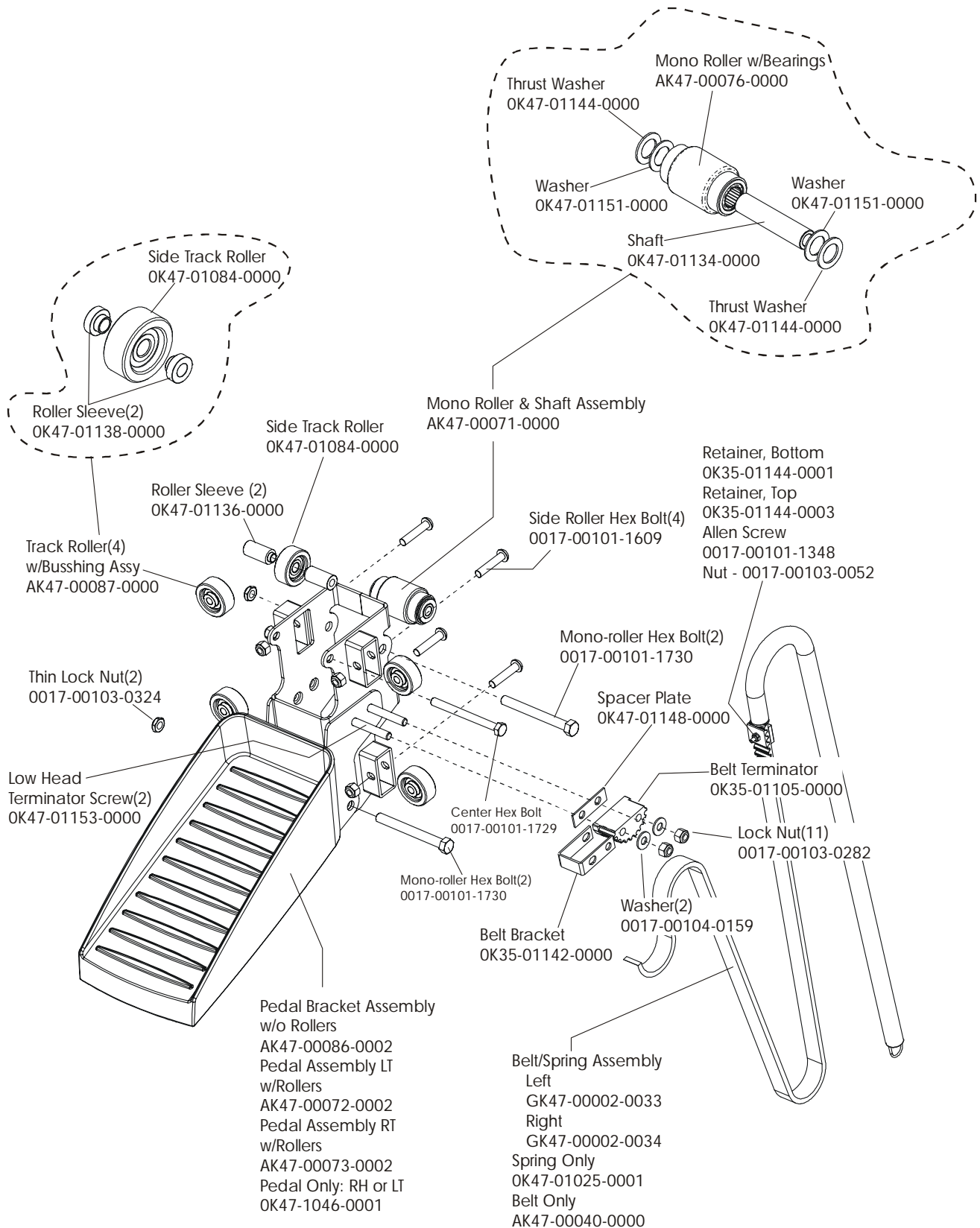

ARCTIC SILVER 95SE
Clutch/Shaft/Pulley Assembly

95SE-0XXX-04
S/N MSU100000 and up

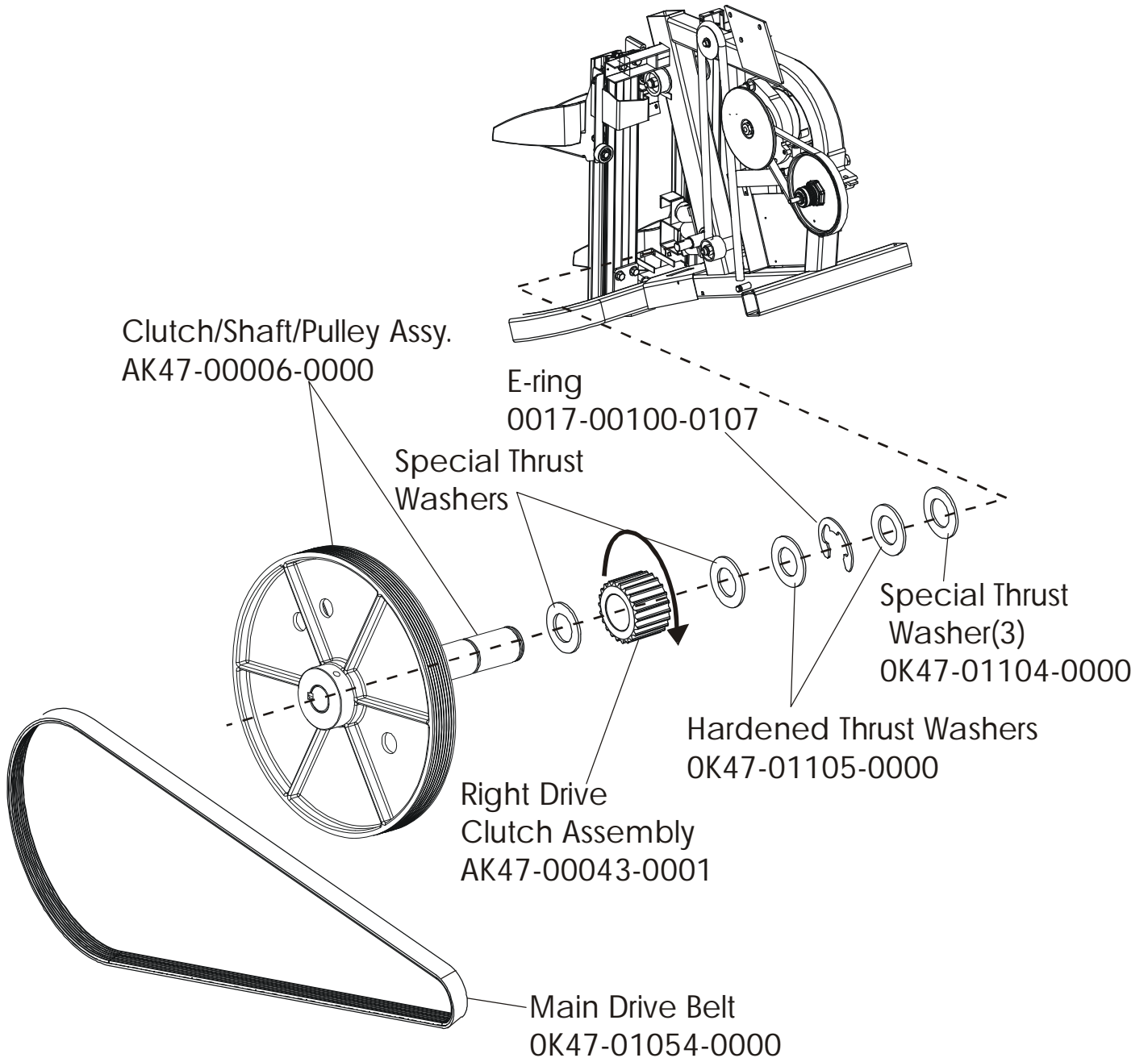

ARCTIC SILVER 95SE
Left Clutch Assembly

95SE-0XXX-04
S/N MSU10000 and up

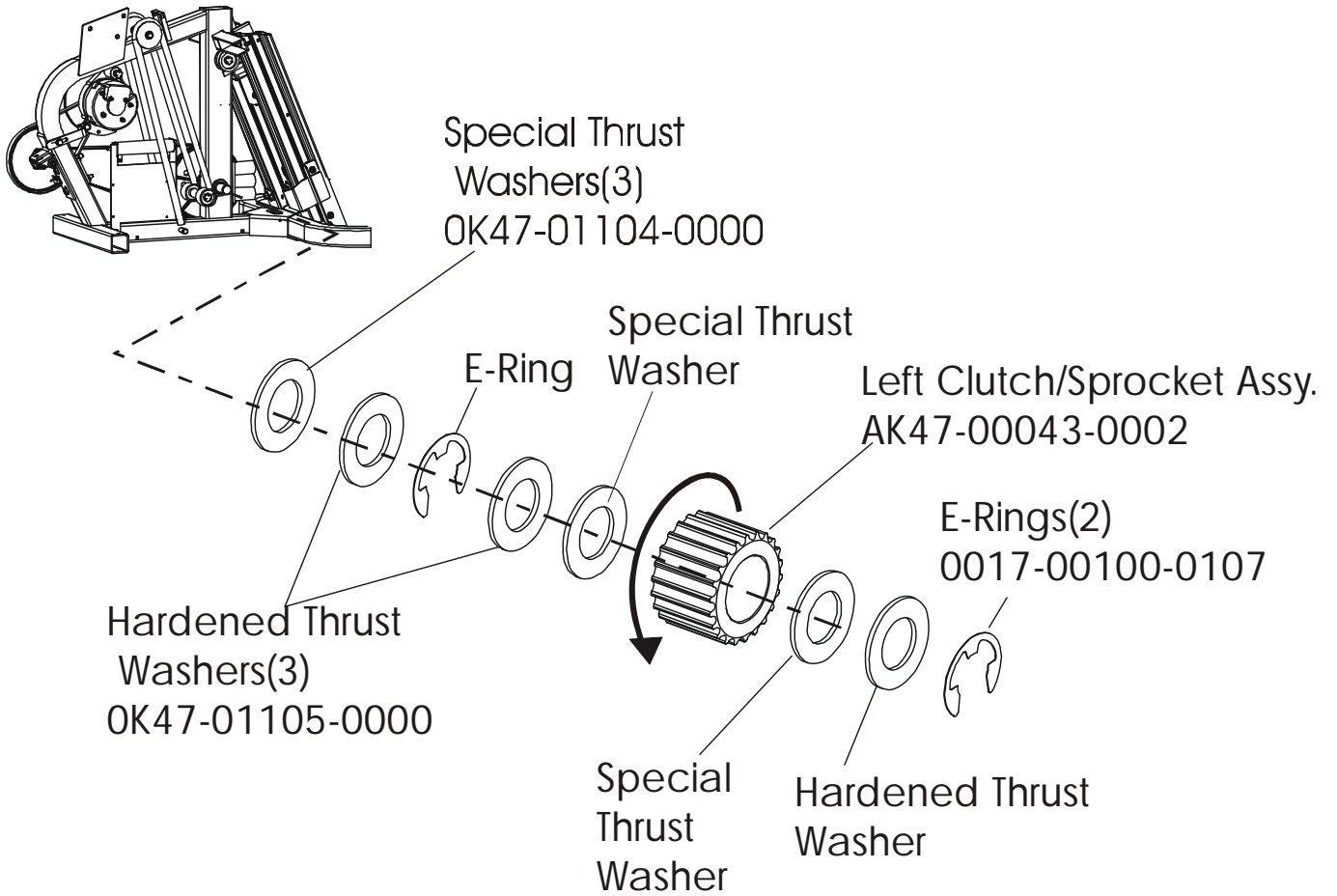

ARCTIC SILVER 95SE
Crossover Pulley Assembly

95SE-0XXX-04
S/N MSU100000 and up

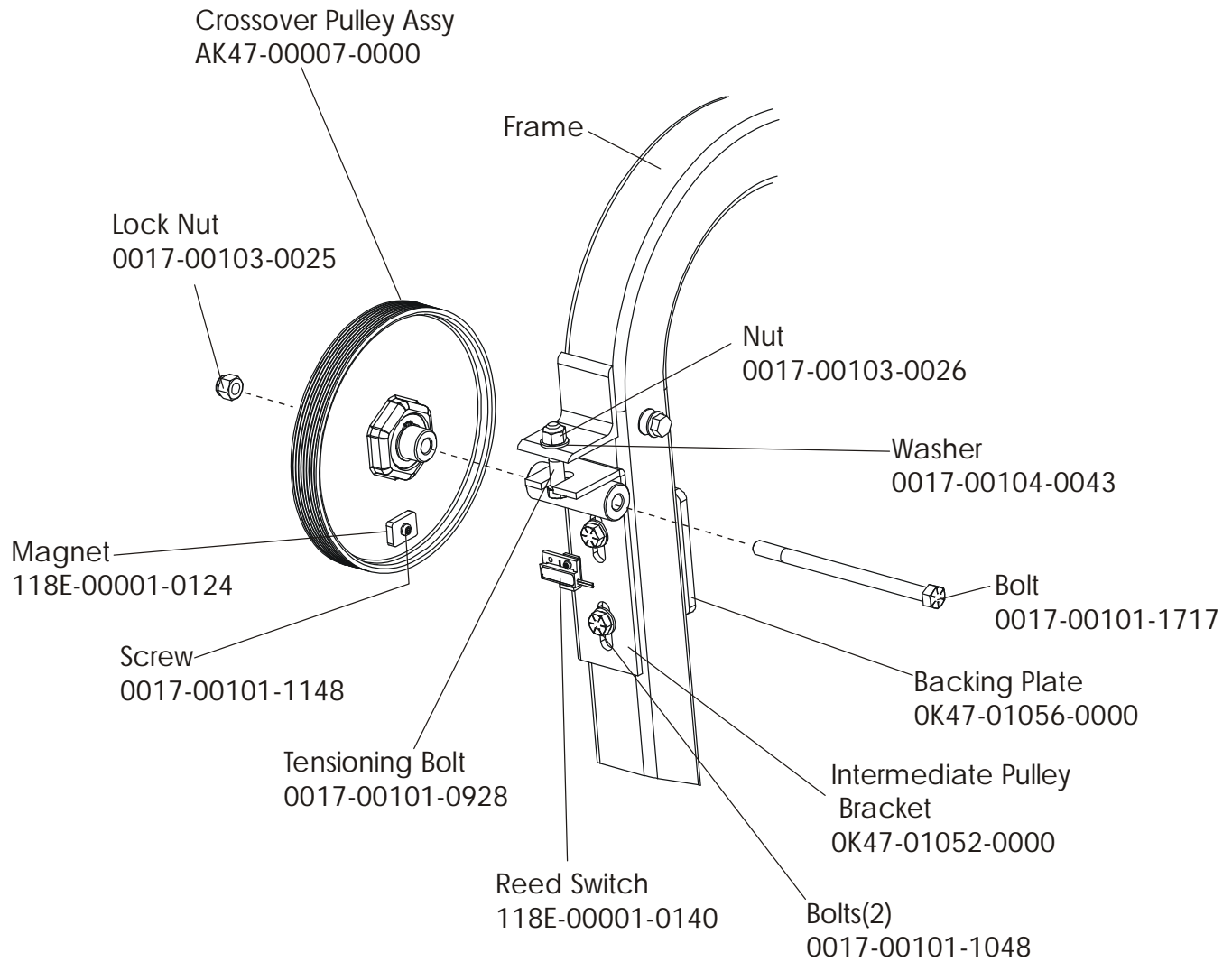

ARCTIC SILVER 95SE
Alternator Assembly

95SE-0XXX-04
S/N MSU10000 and up

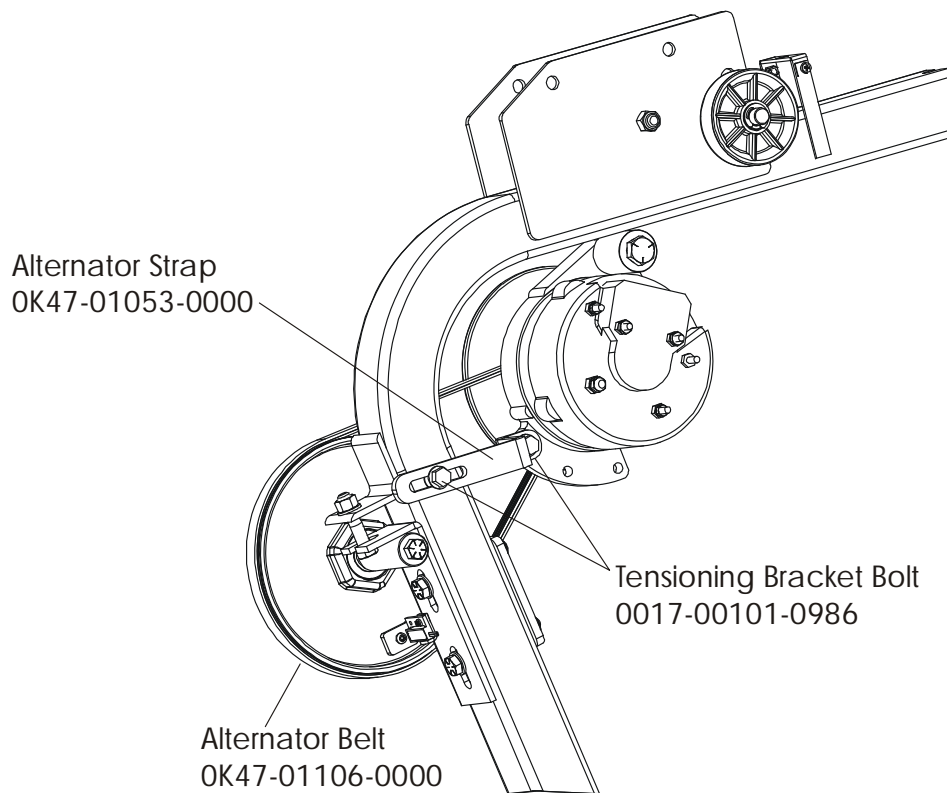
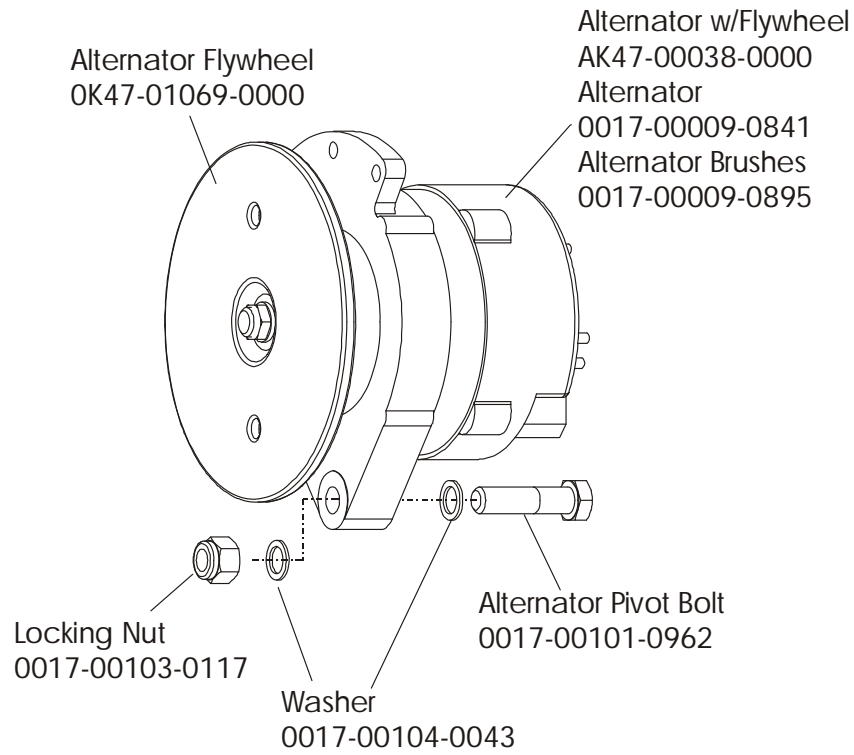

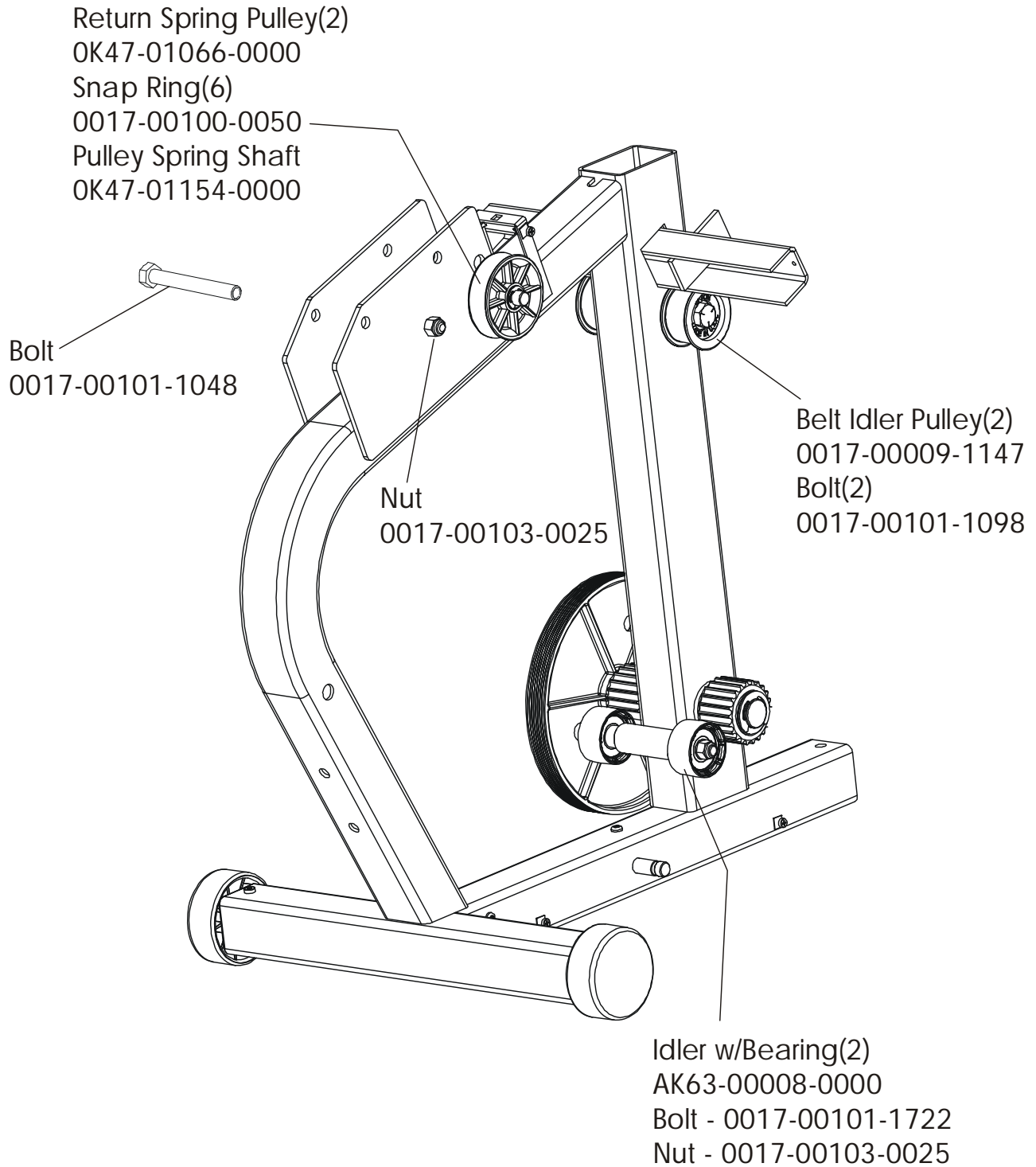

ARCTIC SILVER 95SE
Power Control Board & Resistor

95SE-0XXX-04
S/N MSU100000 and up

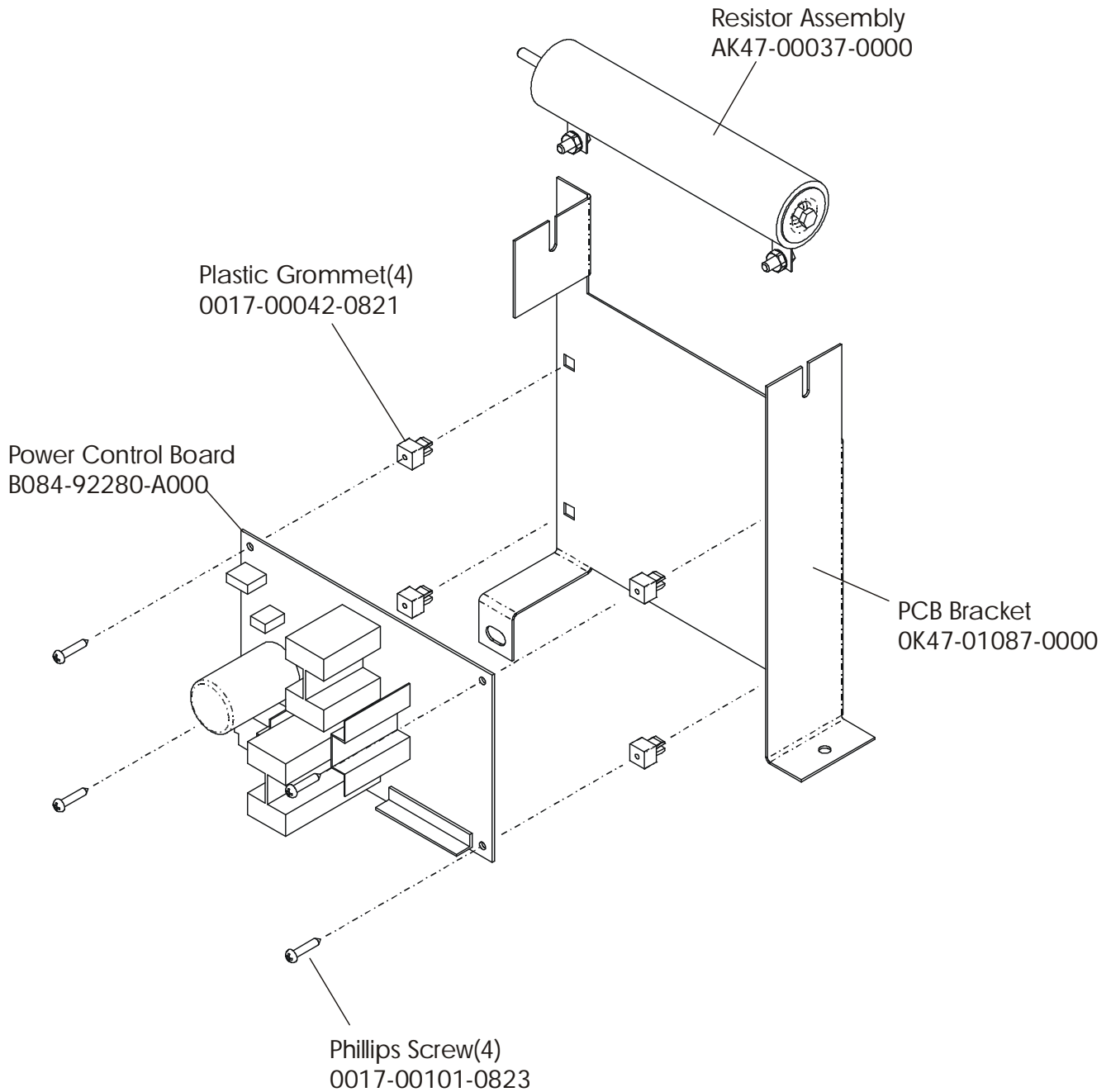

ARCTIC SILVER 95SE
Polar Cap & HR Electrodes

95SE-0XXX-04
S/N MSU100000 and up

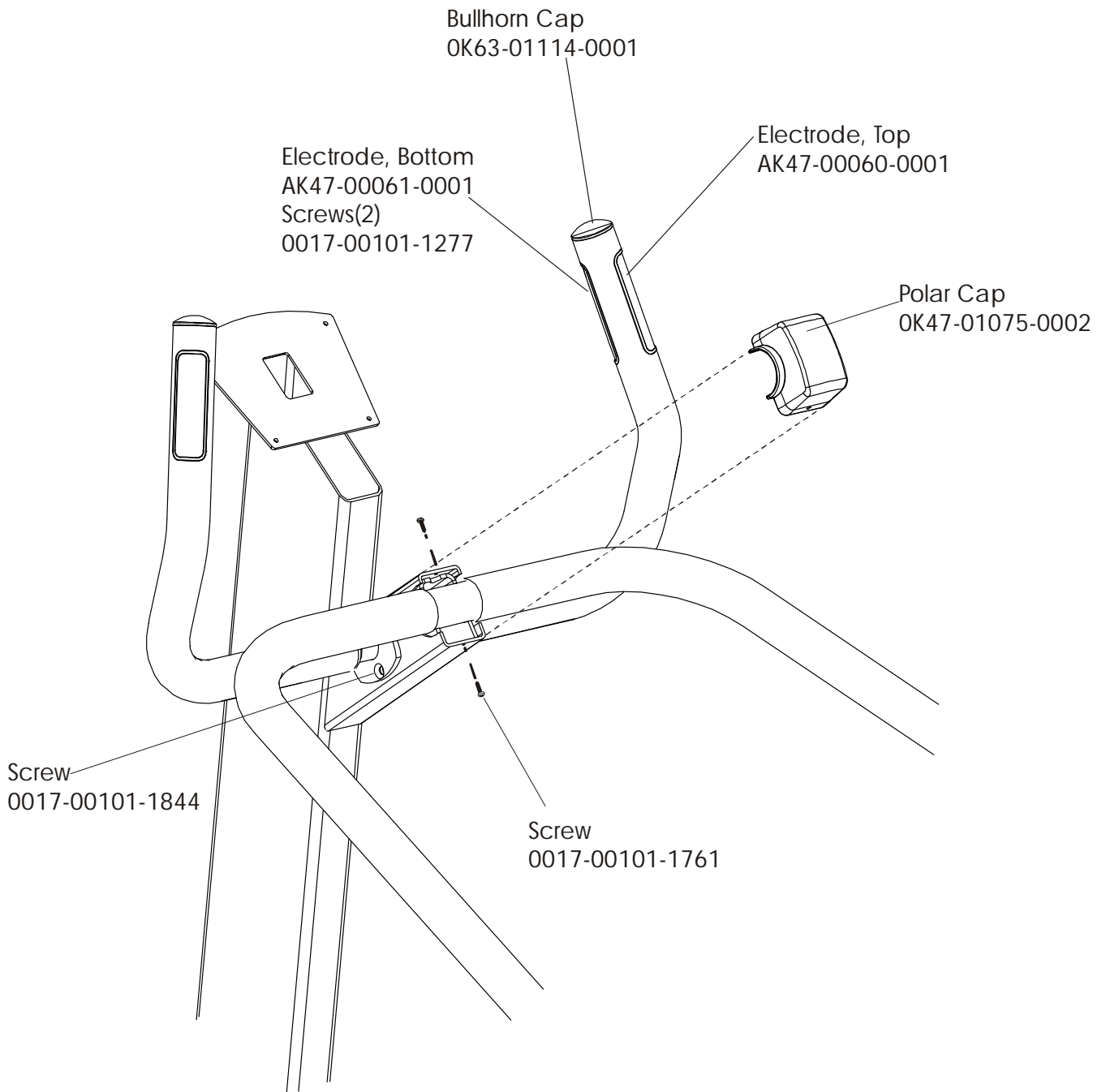

ARCTIC SILVER 95SE

Cables

95SE-0XXX-04
S/N MSU10000 and up

